

Television Suppression

Your Hornby locomotive incorporates radio and television interference suppressors. Should interference be experienced despite these precautions, it may be due to close proximity of the model railway layout to receivers, aerials, or their 'downlines'. In this case, move the layout further away from aerials and receivers.

It is most important that track and wheels be kept absolutely clean.

Spare Parts and Service

Spare parts packs can be obtained from Hornby Service Dealers who are also able to offer a repair service.

Safety Notes

- This locomotive is not suitable for children under 14 years of age. Handle with care.
- This locomotive is intended for indoor use only.
- The transformer is not a toy. It is a 'Transformer for Toys'. Before use, check that the transformer is the correct voltage for your mains electricity supply. This locomotive is only to be used with the recommended transformer. The transformer should be examined regularly for damage to the casing, plug pins and cables.
- This locomotive must not be connected to more than the recommended number of power supplies. The out-put terminals of the transformer must not be connected directly, or indirectly, to the output of any other AC circuit derived from a transformer or mains power supply.
- Before cleaning any part, disconnect the transformer from the mains electricity supply.

Do not use liquid for cleaning.

- Please retain these details and address for future reference.

In the event of such damage, the set should not be used until the transformer is replaced with a new Hornby recommended unit. Never attempt to open the transformer yourself.

IMPORTANT

- Only remove the locomotive from the packaging by carefully pushing through the finger holes below and carefully lifting.
- This locomotive is made to exacting fine scale standards and therefore necessarily incorporates small, delicate, protruding parts – handle with care.
- Before using the model, read through the Operating and Maintenance Instructions in this leaflet.



Waste electrical products should not be disposed of with household waste. Please recycle where facilities exist. Check with your Local Authority or retailer for advice

FOWLER, CLASS 4F 0-6-0 LOCOMOTIVE AND TENDER

FOWLER, CLASS 2P 4-4-0 LOCOMOTIVE AND TENDER

DCC Ready/ DCC Fitted

Operating and Maintenance Instructions

General

Please read right through these instructions, particularly the Safety Notes on page 4.

Hornby locomotives are precision built and, if treated with care, will give many years of good service. Care should be taken to avoid damage when handling the model.

This locomotive should not be operated on track curves of less than 438mm radius, which is Hornby 2nd radius track.

The five-pole electric motor of the locomotive is designed to be operated from a variable 12 volts, DC power supply only. This should be obtained by using a suitable Power Controller operated from the normal domestic mains electricity supply.

NEVER CONNECT A LOCOMOTIVE DIRECTLY TO THE MAINS ELECTRICITY SUPPLY.

The locomotive will normally draw a current of between .2 and .4 amp depending upon the track configuration and whether or not gradients are included. There will be a current surge on starting the locomotive.

DCC Ready

Contact your specialist dealer for advice.

Running Hints

If a locomotive ceases to respond normally to the power controller, or runs badly, check that the following are in order:

- All electrical connections are correctly made and the wall power socket is switched 'ON'.
- The power connecting clip is correctly inserted into a suitable section of track.
- All track sections are correctly fitted together and all fishplates (rail-joiners) are fitting tightly onto adjoining metal rails.
- All locomotive wheels are correctly positioned on the track rails.
- The direction control switch on the train controller is set to operate in ONE direction or the other, and not in the central 'OFF' position.

Routine Maintenance

Track Cleaning – In normal use, model railway layouts will eventually accumulate a blackish deposit on the running surfaces of the rails, and some of this will be transferred onto the locomotive's pick-up wheels.

The 12 volt DC supply is collected from the track through the wheels on one side of the locomotive and returned through the wheels on the other side. If the deposit is allowed to build up, it will have the following adverse effects:

- The driving wheels will not be able to achieve maximum traction
- There will be a reduction in the power reaching the locomotive motor

It is therefore essential that the track, **and wheels**, are kept clean. This can be done by wiping the surfaces with a clean, non-fluffy cloth. More stubborn deposits can be removed by using the Hornby Track Cleaning Rubber, reference R8087, which can be obtained from Hornby Service Dealers.

Motor – The locomotive is fitted with a sealed, long-life, 5-pole motor which requires no maintenance. After a considerable amount of use the motor may require replacement and this should be carried out by a Hornby Service Dealer.

Chassis – The locomotive chassis may, from time to time, pick up fluff, fabric fibres and pet hairs which can become entangled in the gears and around axles. For this reason, it is not advisable to run the locomotive on track which is laid on a carpet. It is important to check regularly and remove any such debris with the aid of small tweezers.

Lubrication – Although the locomotive was lubricated during manufacture, the lubricant can sometimes dry out in storage. Lubrication should be carried out at approximately 6-monthly intervals, or every 100 hours of running. Instructions for carrying out lubrication procedures are given in section 1 on pages 2 and 3.

Locomotive Bodywork – The locomotive body is overall spray painted and the rest of the decoration is applied by a printed process, not transfers.

1 Lubrication

IMPORTANT – Only apply small single drops of light machine oil to the places indicated in red in Figs 2, 3, 4 and 5. This is best achieved by making a simple oil ‘dropper’ as illustrated in Fig. 1. Insert a straightened paper clip into a cork and use a bottle cap as a container for the oil. A small drop of oil can then be picked up by the dropper and applied in exactly the right place. Immediately wipe off any excess oil, especially from the locomotive body. Only lubricate moving parts.

Fig.1

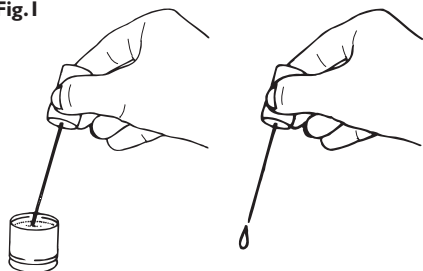

Fig.2/3 Apply one drop of oil to each of the valve gear and connecting rod pivot points indicated in red in Fig.2 and Fig.3, on both sides of the locomotive.

Fig.2
Class 4F

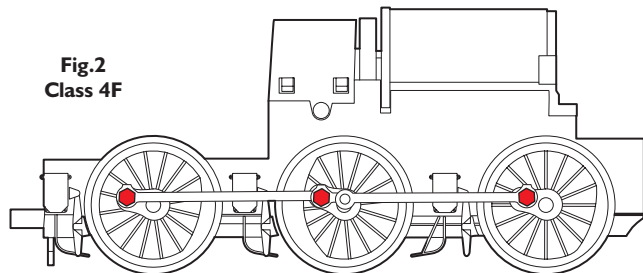

Fig.3
Class 2P

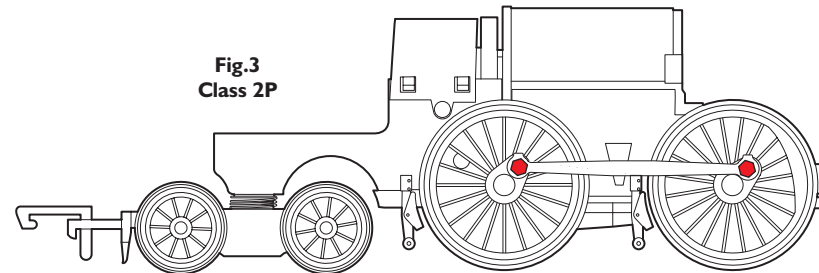

Fig.4/5 Apply one drop of oil to each of the axle bearings indicated in red in Fig.4 and Fig.5.

Fig.4
Class 4F

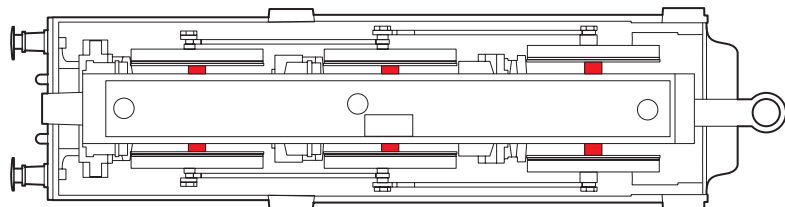
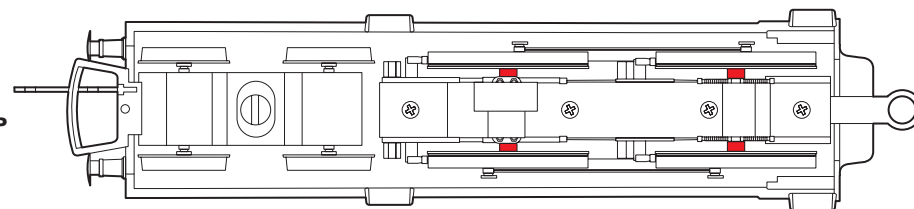

Fig.5
Class 2P



2 Tender Body Removal

Turn the tender upside down, remove the Drawbar screw as shown in Fig.6. Carefully turn the tender the right way up and ease the body up and disengage the body from the rear of the chassis as shown in Fig.7.

Fig.6

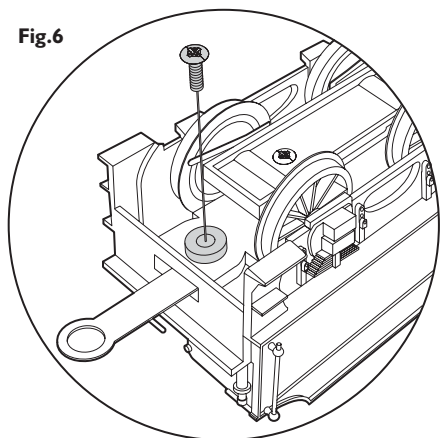
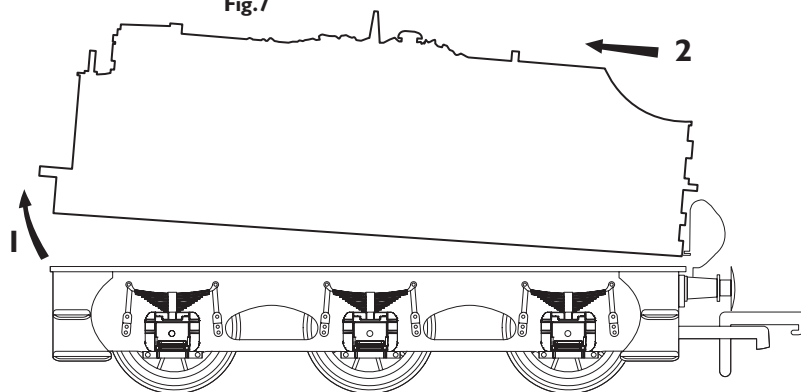

Fig.7



3 DCC Ready

If your locomotive is not pre-fitted with a decoder, please see Fig.8 for location of DCC socket.

Fig.8

